

# Service Manual

# THE FISHER®

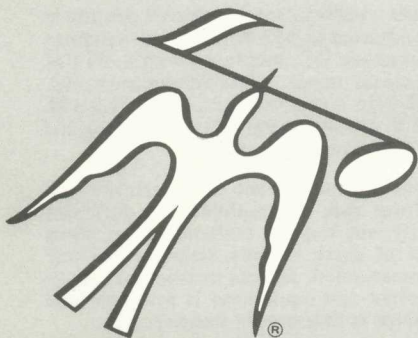
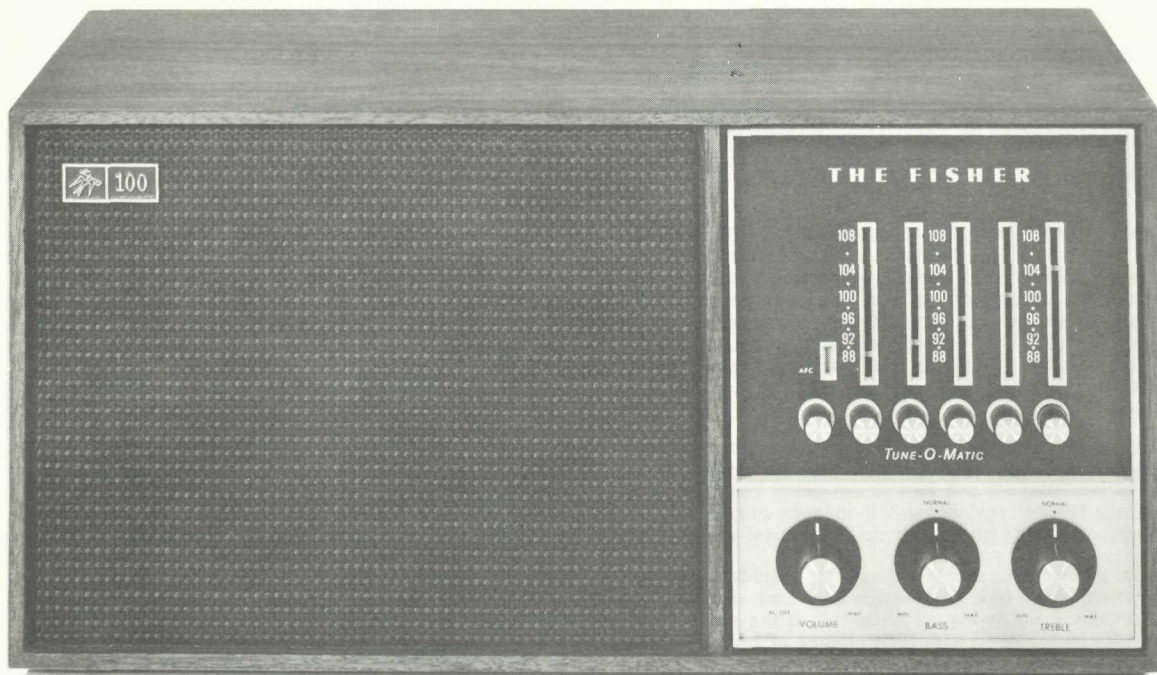

# 100™

CHASSIS SERIAL NUMBERS  
BEGINNING 10001

PRICE \$1.00



**CAUTION:** This is a FISHER precision high-fidelity instrument. It should be serviced only by qualified personnel — trained in the repair of transistor equipment and printed circuitry.

### TEST EQUIPMENT REQUIRED

The following are needed to completely test and align modern high-fidelity instruments such as amplifiers, tuners and receivers.

Vacuum-Tube Voltohmmeter (100-mV DC scale)	10.7-MHz Sweep Generator
Audio Vacuum-Tube Voltmeter (10-mV AC scale)	455-kHz Sweep Generator
Oscilloscope (Flat to 100 kHz Minimum)	Line Voltage Autotransformer or Voltage Regulator
Audio (Sine-Wave) Generator	2 — Load Resistors, 4 or 8 Ohm, 50 Watt
Intermodulation Distortion Analyzer	2 — Full Range Speakers for Listening Tests
Harmonic Distortion Analyzer	Stereo Source — Turntable or Tape Recorder for Listening Tests
AM/FM Signal Generator	Soldering Iron with Small Tip
Multiplex Generator (preferably with RF output — FISHER Model 300 or equal)	Fully Insulated from Power Line
	Suction Desoldering Tool

### PRECAUTIONS

Many of these items are included just as a reminder—they are normal procedures for experienced technicians. Shortcuts can be taken but often they cause additional damage—to transistors, circuit components or the printed-circuit board.

**Soldering**—A well-tinned, hot, clean soldering iron tip will make it easier to solder without damage to the printed-circuit board or the many circuit components mounted on it. It is not the wattage of the iron that counts—it is the heat available at the tip. Some 50-watt irons reach temperatures of 1,000° F—others will hardly melt solder. Small-diameter tips should be used for single solder connections—larger pyramid and chisel tips are needed for larger areas.

- When removing defective resistors, capacitors, etc., the leads should be cut as close to the body of the circuit component as possible. (If the part is not being returned for in-warranty factory replacement it may be cut in half—with diagonal-cutting pliers—to make removal easier.)

- Special de-soldering tips are made for unsoldering multiple-terminal units like IF transformers and electrolytic capacitors. By unsoldering all terminals at the same time the part can be removed with little chance of breaking the printed-circuit board.

- Always disconnect the chassis from the power line when soldering. Turning the power switch OFF is not enough. Power-line leakage paths, through the heating element, can destroy transistors.

**Transistors**—Never attempt to do any work on the transistor amplifiers without first disconnecting the AC linecord and waiting until the power supply filter-capacitors have discharged.

- Guard against shorts—it takes only an instant for a base-to-collector short to destroy that transistor and possibly others direct-coupled to it. [In the time it takes for a dropped machine screw, washer or even the screwdriver, to glance off a pair of socket terminals (or between a terminal and the chassis) a transistor can be ruined.]

- DO NOT bias the base of any transistor to, or near, the same voltage applied to its collector.

- DO NOT use an ohmmeter for testing transistors. The voltage applied through the test probes may be higher than the base-emitter breakdown voltage of the transistor.

**Output Stage and Driver — Replacements for output and**

driver transistors, if necessary, must be made from the same beta group as the original type. The beta group is indicated by a colored dot on the mounting flange of the transistor. Be sure to include this information, when ordering replacement transistors.

- If one output transistor burns out (open or shorts), always remove ALL output transistors in that channel and check the bias adjustment, the control and other parts in the network with an ohmmeter before inserting a new transistor. All output transistors in one channel will be destroyed if the base-biasing circuit is open on the emitter end.

- When mounting a replacement power transistor be sure the bottom of the flange, the mica insulator and the surface of the heat sink are free of foreign matter. Dust and grit can prevent perfect contact reducing heat transfer to the heat sink. Metallic particles can puncture the insulator and cause shorts—ruining the transistor.

- Silicone grease must be used between the transistor and the mica insulator and between the mica and the heat sink for best heat conduction. (Use Dow-Corning DC-3 or C20194 or equivalent compounds made for power transistor heat conduction.)

- Use care when making connections to speakers and output terminals. Any frayed wire ends can cause shorts that may burn out the output transistors—they are direct-coupled to the speakers. To reduce the possibility of shorts at the speakers, lugs should be used on the exposed ends or at least the ends of the stranded wires should be tinned to prevent frayed wire ends. The current in the speakers and output circuitry is quite high. Poor contacts or small size wire can cause power losses in the speaker system. Use 14 or 16 AWG for long runs of speaker wiring.

**Voltage Measurements**—Voltage measurements are made with the line voltage adjusted to 117 volts and all readings are  $\pm 10\%$ . All voltages are DC, measured with a VTVM to ground, with no signal input unless otherwise noted.   indicates 1-kHz audio voltages, measured with an audio AC VTVM to ground at various points from the phono input to the power amplifier output.

**Alignment Procedures — Replacement of transistors and components in the front end, IF amplifier and multiplex decoder will normally not require realignment of these circuits. Realignment of these circuits, unless absolutely necessary, is not recommended. Do not attempt a realignment unless the required test equipment is available and the alignment procedure is thoroughly understood.**

BECAUSE ITS PRODUCTS ARE SUBJECT TO CONTINUOUS IMPROVEMENT, FISHER RADIO CORPORATION RESERVES THE RIGHT TO MODIFY ANY DESIGN OR SPECIFICATION WITHOUT NOTICE AND WITHOUT INCURRING ANY OBLIGATION.



## SERVICE PROCEDURES

### REMOVING THE CHASSIS FROM CABINET

- (1) Disconnect the AC power cord.
- (2) Prop the unit on its side edge. Remove the screw at the bottom front of the cabinet.
- (3) Remove the three screws at the rear of the cabinet. Ease the chassis out of the cabinet from the front by pushing gently on the rear hear sink.
- (4) To remove the control panel, gently pull the VOLUME, BASS and TREBLE knobs off the control panel shafts. Gently push in the four plastic bushings that protrude through the chassis front panel to release the control panel.
- (5) To remove the speaker and the speaker baffle board, place a screwdriver between the baffle board and the chassis front panel near the three mounting screws and pry off the board.
- (6) To replace the chassis, follow the reverse of the preceding instructions. Make certain that the foam tape seals the rear of the chassis and the heat sink before replacing the screws which hold the chassis in the cabinet.

### CLEANING CONTROL PANEL

**WARNING:** Use only plain lukewarm water and a freshly laundered, soft, lint-free cloth to clean the control panel.

### INTERMODULATION DISTORTION TEST

- Set BASS and TREBLE controls to their center positions. Unplug AC power cord.
- (1) Disconnect the lead going to pin 2P on the audio control, power amplifier and power supply board. Connect IM-analyzer generator output to pin 2P through a 4.7K ohm, 5% resistor.
  - (2) Disconnect the leads going to the internal speaker. Connect an 8-ohm, 10-watt resistor across these leads. In parallel with the load resistor, connect the input leads of an IM (Inter-Modulation) distortion analyzer and the input leads of an AC VTVM capable of reading 0.1 volts with accuracy.
  - (3) Connect AC power cord and rotate VOLUME control to its 12 o'clock position.
  - (4) Increase IM-analyzer generator input to set for 0.6 watts output (1.8 VAC across 8-ohm load resistor). AFTER ONE FULL MINUTE OF WARM-UP TIME, PROCEED TO NEXT STEP.
  - (5) IM meter reading should be 1.0% or less.
- NOTE:** If any of the preceding instructions are different from those supplied with the IM-analyzer instruction manual, it is best to follow those in the manual. If a load resistor of 10-watt rating is built into the IM analyzer, a separate load resistor is not required.

### HARMONIC DISTORTION TEST

- Set BASS and TREBLE controls to their center positions. Unplug AC power cord.
- (1) Disconnect the lead going to pin 2P on the audio control, power amplifier and power supply board. Connect a low-distortion audio sine wave generator, set for 1000 Hz (cps), to pin 2P through a 4.7K ohm, 5% resistor.
  - (2) Disconnect the leads going to the internal speaker. Connect an 8-ohm, 10-watt resistor across these leads. In parallel with the load resistor, connect the input leads of a harmonic distortion analyzer and the input leads of an AC VTVM capable of reading 0.1 volts with accuracy.
  - (3) Connect AC power cord and rotate VOLUME control to its 12 o'clock position.
  - (4) Increase audio generator input to set for 1 watt output (2.83 VAC across 8-ohm load resistor). Harmonic distortion meter should read 0.6% or less.

### POWER OUTPUT MEASUREMENT

The output amplifier of this unit is designed to deliver its full-rated power with program material (voice or music) into 4- to 8-ohm loads for an indefinite period of time. When a constant audio tone is used as a signal to measure the continuous RMS power output, the following precaution must be taken: limit the measurement period to 5 minutes with a load resistance of 8 ohms.

### FM FRONT END ALIGNMENT

- NOTE:** FM IF alignment must be performed before start-up this procedure.
- Set VOLUME control to 12 o'clock position, BASS and TREBLE controls to NORMAL. Set AFC knob to the left so that the red flag disappears from the window above it (AFC OFF).
- (1) Connect a scope and AC VTVM to Test Point 302 on the IF amplifier board.
  - (2) Disconnect link between bottom terminal and EXT ANT. terminal on rear panel. Connect an FM generator to the EXT ANT. terminals through a balun coil.
- NOTE:** The balun coil is necessary to prevent shorting out a portion of the center-tapped antenna coil in the front end.
- (3) Set FM generator frequency to 90 MHz (Mc) and depress any of the tuning knobs and set the pointer to the mark corresponding to 90 MHz (Mc). Modulate the generator with 400 Hz (cps)  $\pm 75$  kHz (kc) deviation. Use as low a generator output as possible.
  - (4) Align FM oscillator coil (L555) core first—then align the FM antenna coil (L551) and the FM mixer coil (L553) cores for maximum reading on AC VTVM and maximum waveform amplitude and symmetry (see Figure 1).
  - (5) Set FM generator frequency to 106 MHz (Mc). Depress another of the tuning knobs and set the pointer to the mark corresponding to 106 MHz (Mc).

- (6) Adjust FM oscillator trimmer (C561) first—then adjust the FM antenna trimmer (C551) and the FM mixer trimmer (C555) for maximum reading on AC VTVM and maximum waveform amplitude and symmetry (see Figure 1).
- (7) Repeat alignment several times until accurate dial calibration and maximum gain are obtained. Keep the generator output as low as possible during all adjustments.

### FM IF ALIGNMENT

- Set VOLUME control to 12 o'clock position, BASS and TREBLE controls to NORMAL. Set AFC knob to the left so that the red flag disappears from the window above it (AFC OFF).
- (1) Connect 10.7-MHz sweep generator to Test Point 551 on the front end. Connect vertical input of scope through a 100K ohm, 5% resistor to Test Point 301 on the IF amplifier.
  - (2) Adjust generator output voltage and frequency to obtain IF response curve. Use as low a generator output as possible.
  - (3) Detune core of transformer Z303 nearest AM Suppression Adjust Pot. R317 on IF amplifier board outwards.
  - (4) Align top and bottom cores of IF transformer (L554) on front end for maximum gain and symmetry (see Figure 2).
- NOTE:** 100 kHz (kc) markers should be 60% down on curve for proper IF bandwidth.
- (5) Align front and rear cores of Z301 and Z302 on IF amplifier board for maximum gain and symmetry (see Figure 2).
  - (6) Repeat alignment several times until maximum gain and symmetry are obtained.
  - (7) Connect vertical input of scope to Test Point 302 on the IF amplifier.
  - (8) Align front and rear cores of Z303 on IF amplifier board for maximum gain and symmetry (see Figure 3).
- NOTE:** 100 kHz (kc) markers should be evenly spaced up and down the curve and equally spaced from the center.
- WARNING:** Proper adjust of Z303 will slightly detune IF response at Test Point 301; do not attempt to correct IF response.

### AM SUPPRESSION AND AFC ADJUSTMENT

- Set VOLUME control to 12 o'clock position, BASS and TREBLE controls to NORMAL. Set AFC knob to the left so that the red flag disappears from the window above it (AFC OFF).
- (1) Connect a scope, AC VTVM and DC VTVM to Test Point 302 on the IF amplifier board. Connect a harmonic distortion meter to the EXT SPKR jack.
  - (2) Disconnect link between bottom terminal and EXT ANT. terminal on rear panel. Connect an FM generator to the EXT ANT. terminals through a balun coil.
- NOTE:** The balun coil is necessary to prevent shorting out a portion of the center-tapped antenna coil in the front end.
- (3) Set AM Suppression Adjust Pot. R317 on the IF amplifier board to its center position.
  - (4) Set FM generator frequency to 90 MHz (Mc) and depress any of the tuning knobs and set the pointer to the mark corresponding to 90 MHz (Mc). Modulate the generator with 400 Hz (cps)  $\pm 75$  kHz (kc) deviation.
  - (5) Adjust generator output for audio signal on scope. Reduce generator output until noise appears on the positive and negative peaks of the audio signal (approximately 2 to 4  $\mu$ V). Observe waveform for proper symmetry (see Figure 1).
  - (6) Adjust generator output for approximately 500  $\mu$ V to 1 mV level. Slightly realign front and rear cores of Z303 on IF amplifier board for maximum reading on AC VTVM and minimum distortion reading on harmonic distortion meter.
- NOTE:** Core furthest from AM Suppression Adjust Pot. R317 has more effect on distortion reading.
- (7) Reduce generator output for approximately 10 to 20  $\mu$ V level and set internal modulation of generator to AM. Adjust modulation control for 100% modulation.
  - (8) Adjust AM Suppression Adjust Pot. R317 for minimum reading on AC VTVM.
  - (9) Reset internal modulation of generator to FM.
  - (10) Adjust DC Zero Adjust Pot. R320 for reading on DC VTVM of 0 VDC.
  - (11) Detune generator frequency slightly until positive peaks of audio signal (Figure 1) show a distinct notch in the peak. Set AFC knob to the right so that the red flag appears in the window above it (AFC ON). Notch should disappear from audio signal.
  - (12) Set AFC knob to OFF and repeat Step 11 for negative peaks of audio signal.

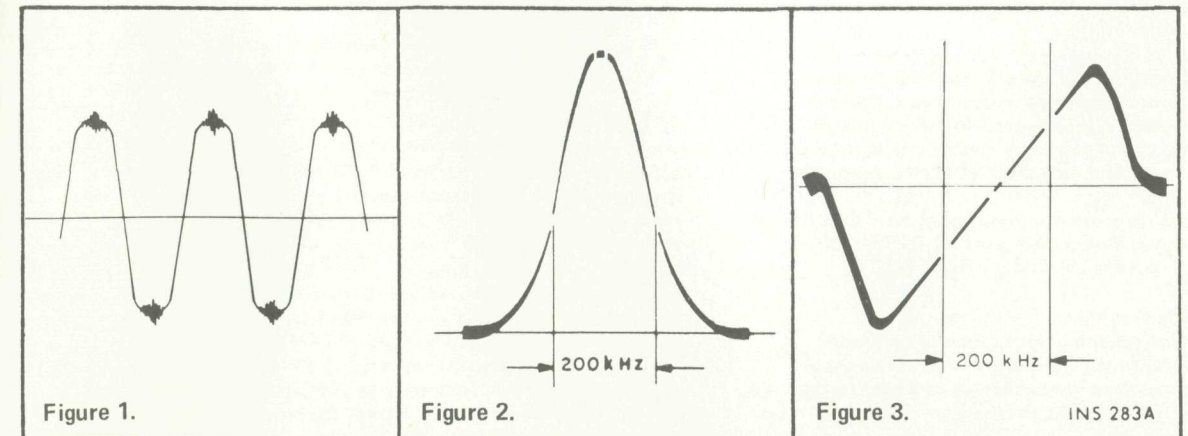



FE51C118 FM FRONT END

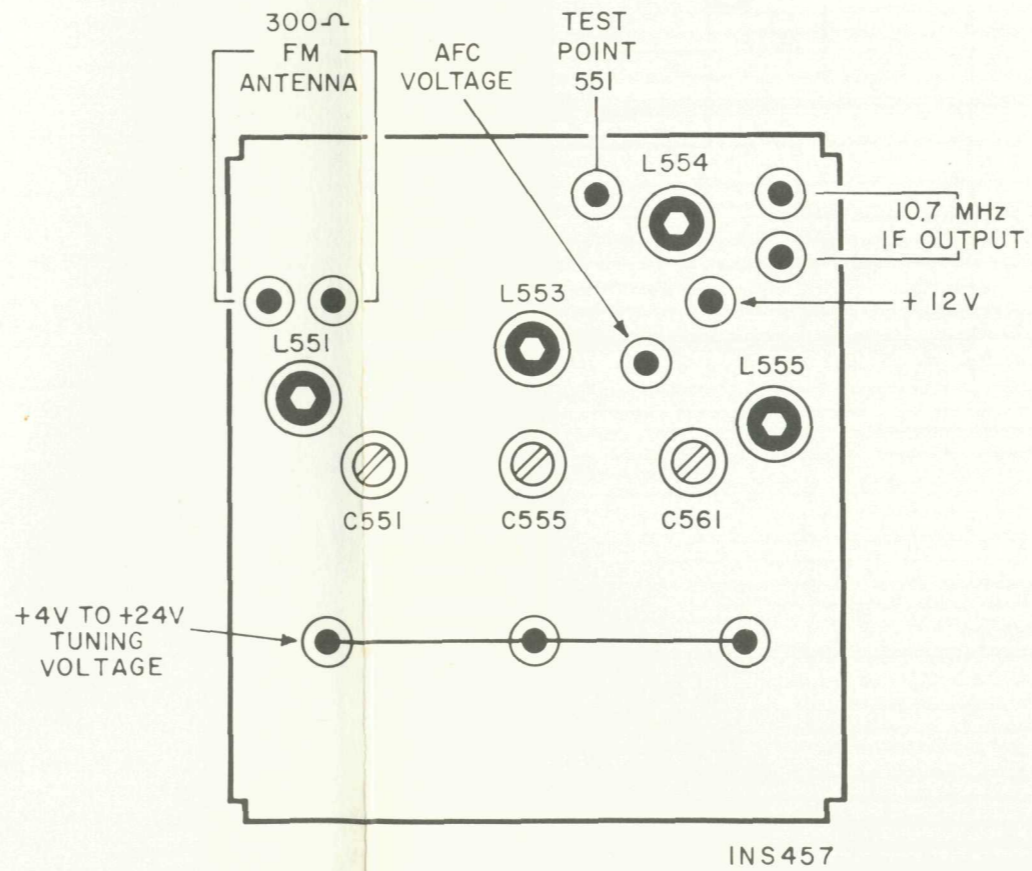
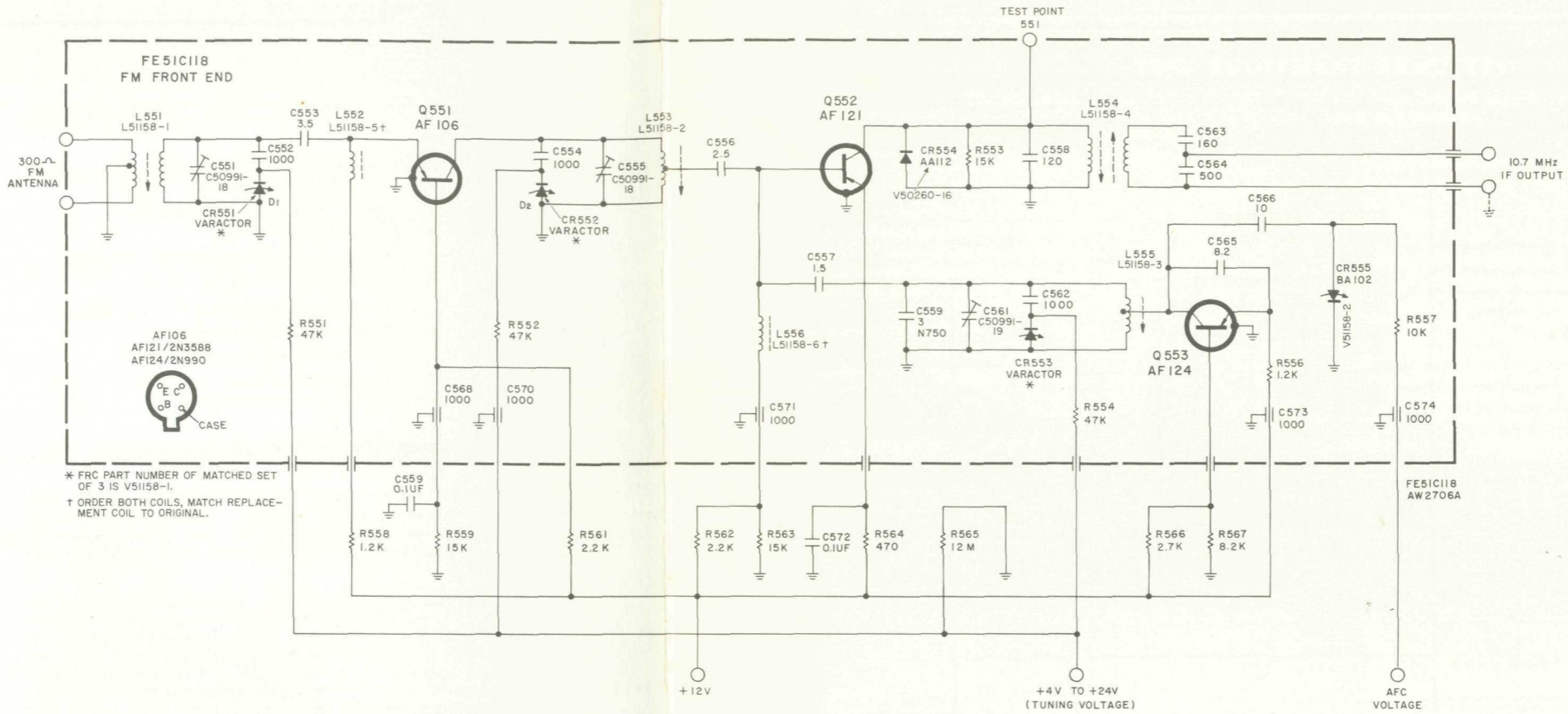



2027 10.7 MHz IF AMPLIFIER

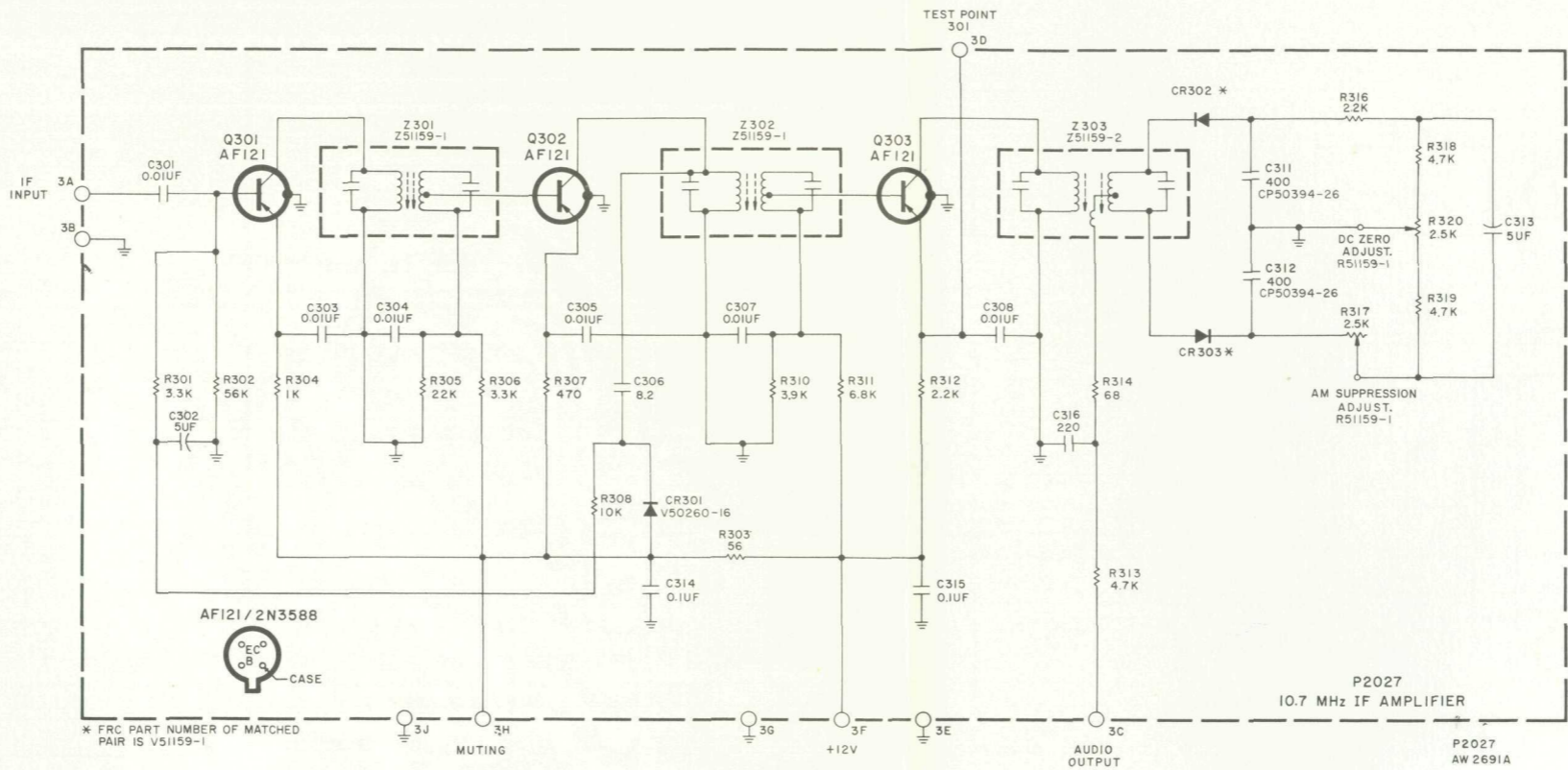

BOARD VIEWED FROM COMPONENT SIDE

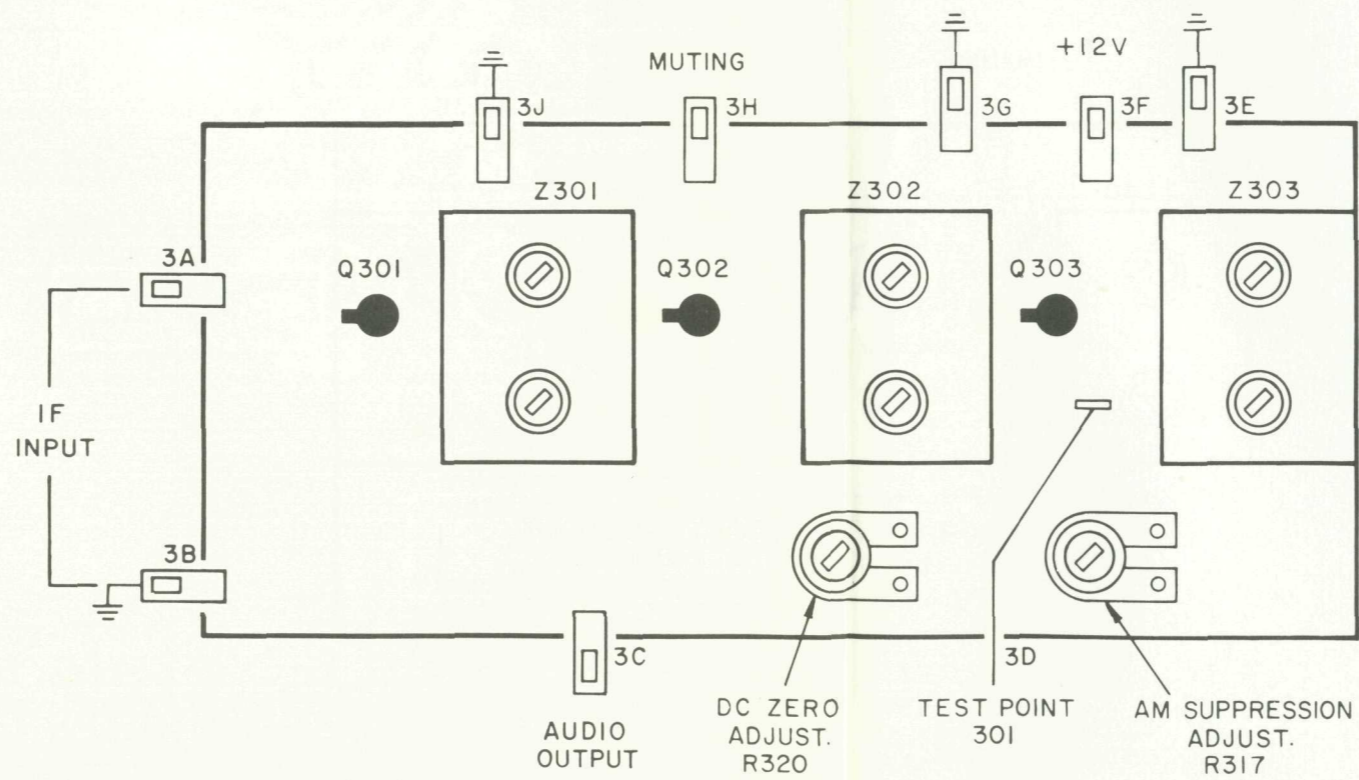



2011 AUDIO CONTROL, POWER AMPLIFIER AND POWER SUPPLY

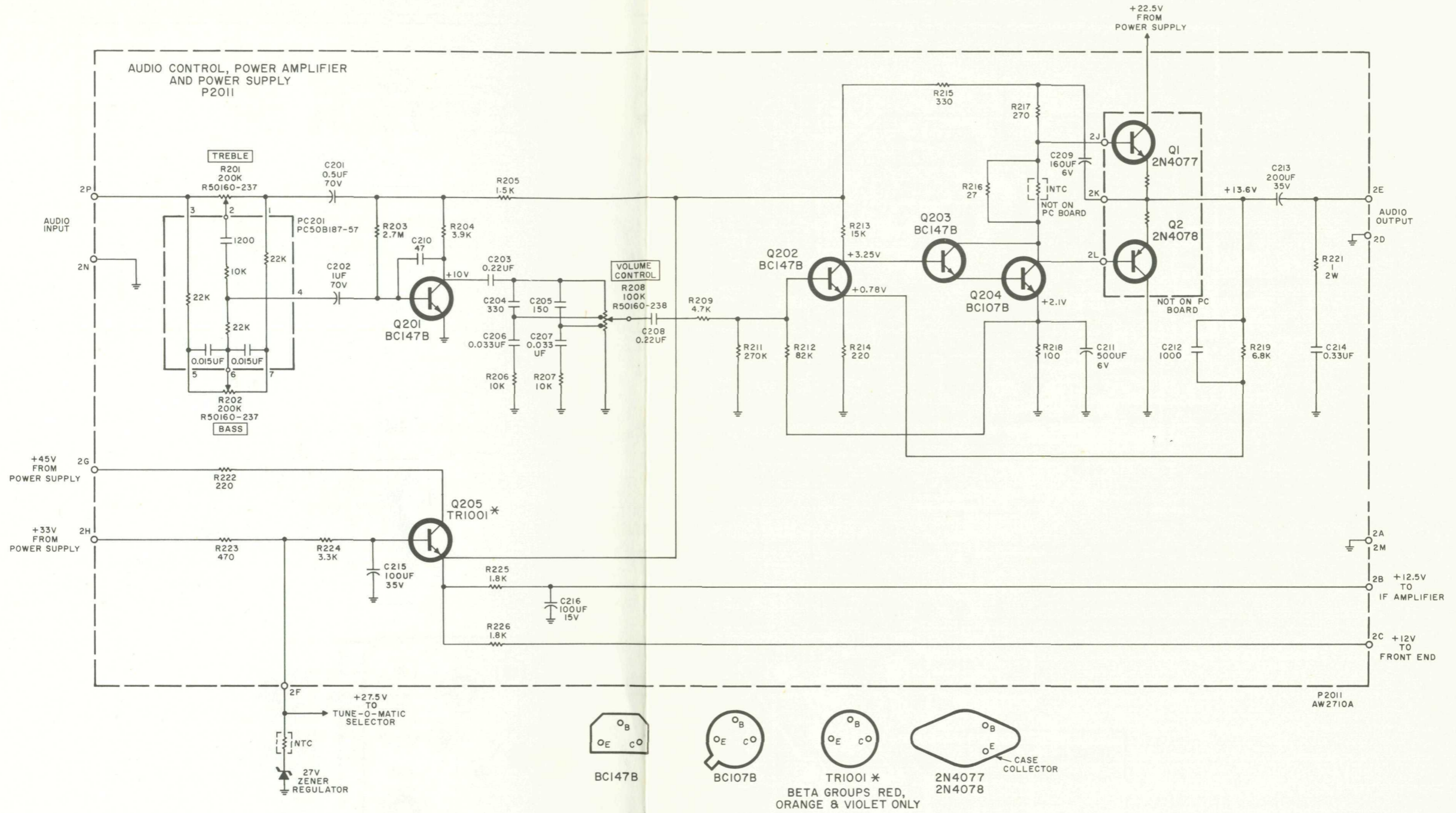

FOR VIEW OF PRINTED CIRCUIT BOARD LAYOUT, SEE FLAP OF REAR COVER



MAIN CHASSIS

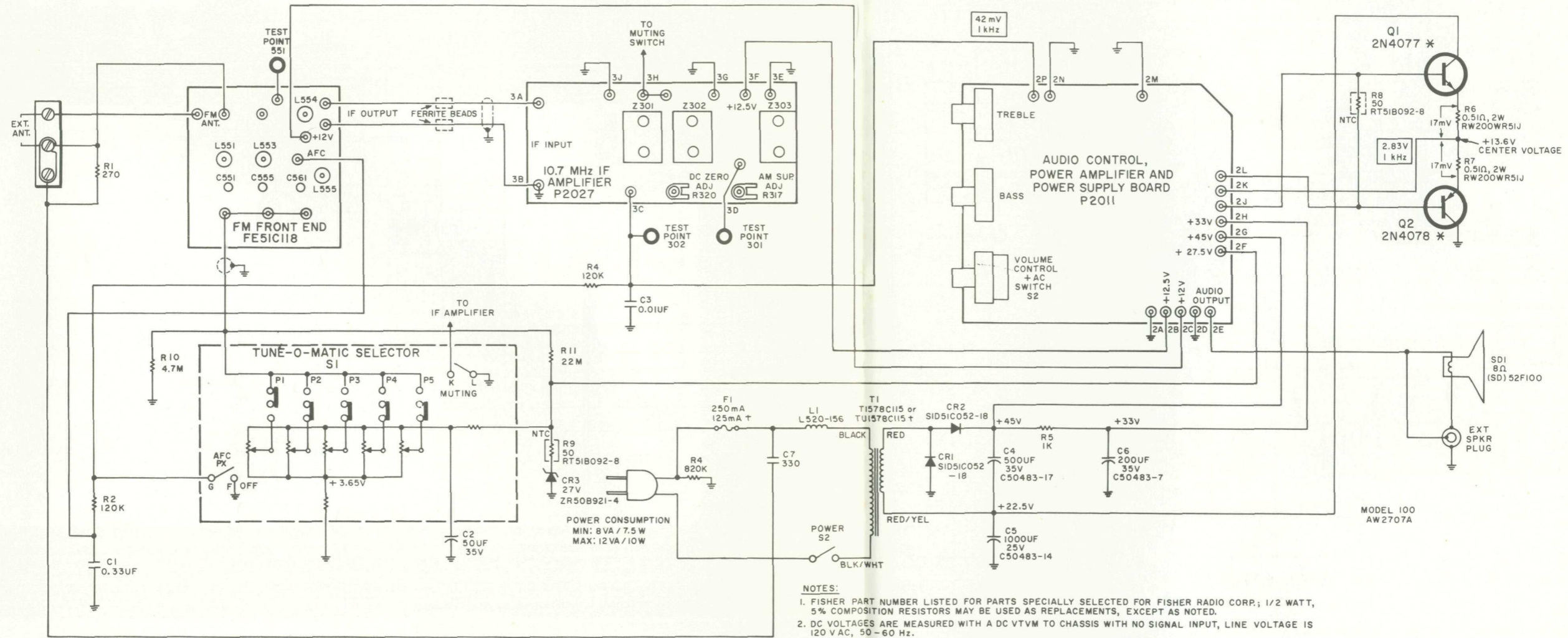

- NOTES:
1. FISHER PART NUMBER LISTED FOR PARTS SPECIALLY SELECTED FOR FISHER RADIO CORP.; 1/2 WATT, 5% COMPOSITION RESISTORS MAY BE USED AS REPLACEMENTS, EXCEPT AS NOTED.
  2. DC VOLTAGES ARE MEASURED WITH A DC VTVM TO CHASSIS WITH NO SIGNAL INPUT, LINE VOLTAGE IS 120 V AC, 50-60 Hz.
  3. POWER TRANSISTORS SOLD ONLY AS A MATCHED PAIR -- PART No. TR2N4079.
  - † 4. USED ON EXPORT UNITS.

TU MULTIVOLTAGE POWER TRANSFORMER STRAPPING

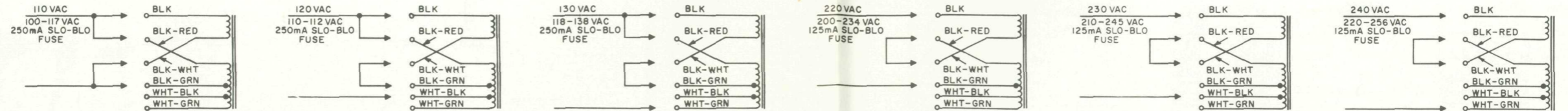



2011 AUDIO CONTROL, POWER  
AMPLIFIER AND POWER SUPPLY

BOARD VIEWED FROM COMPONENT SIDE

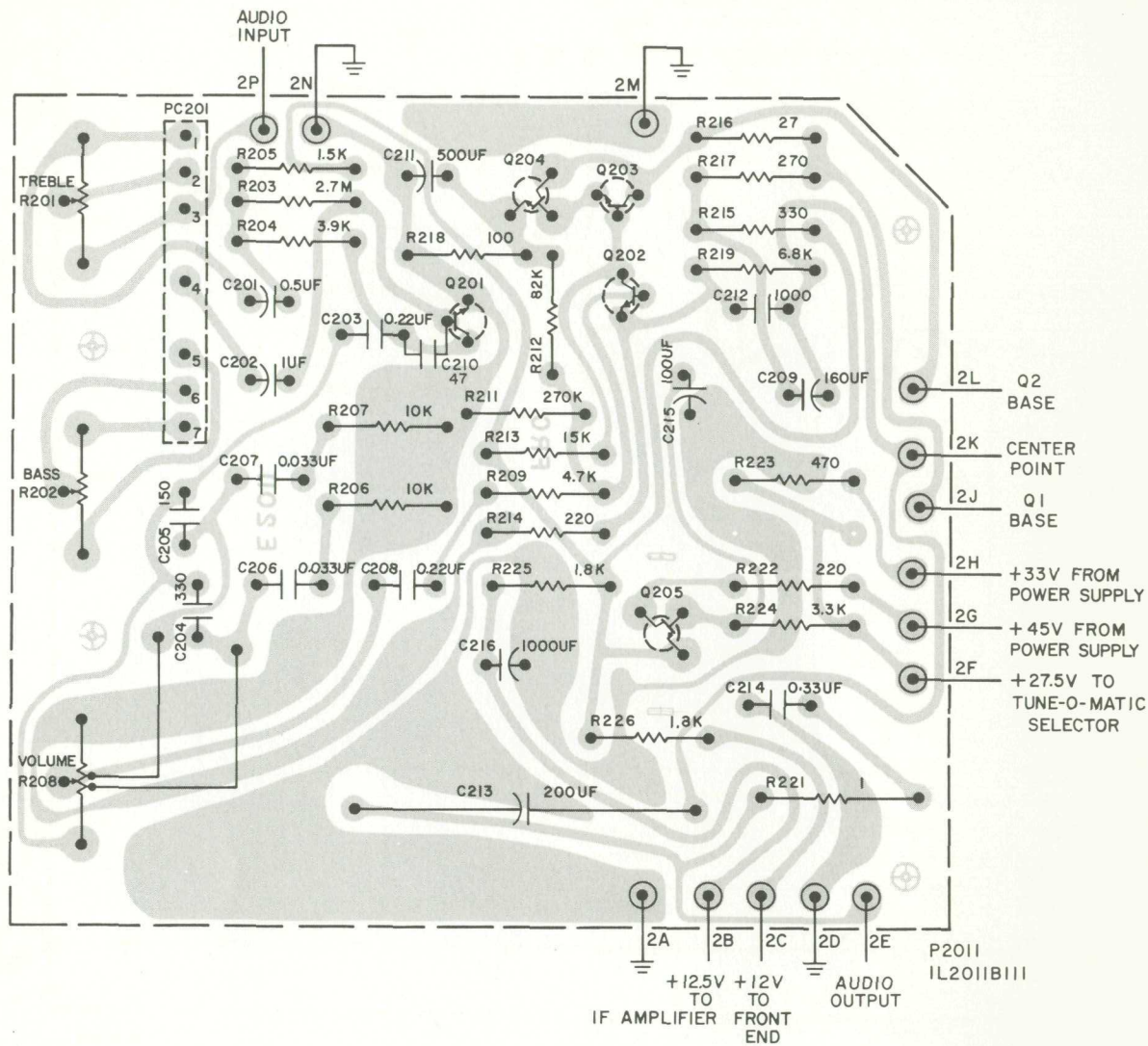

SERVICE NOTES

CHASSIS LAYOUT

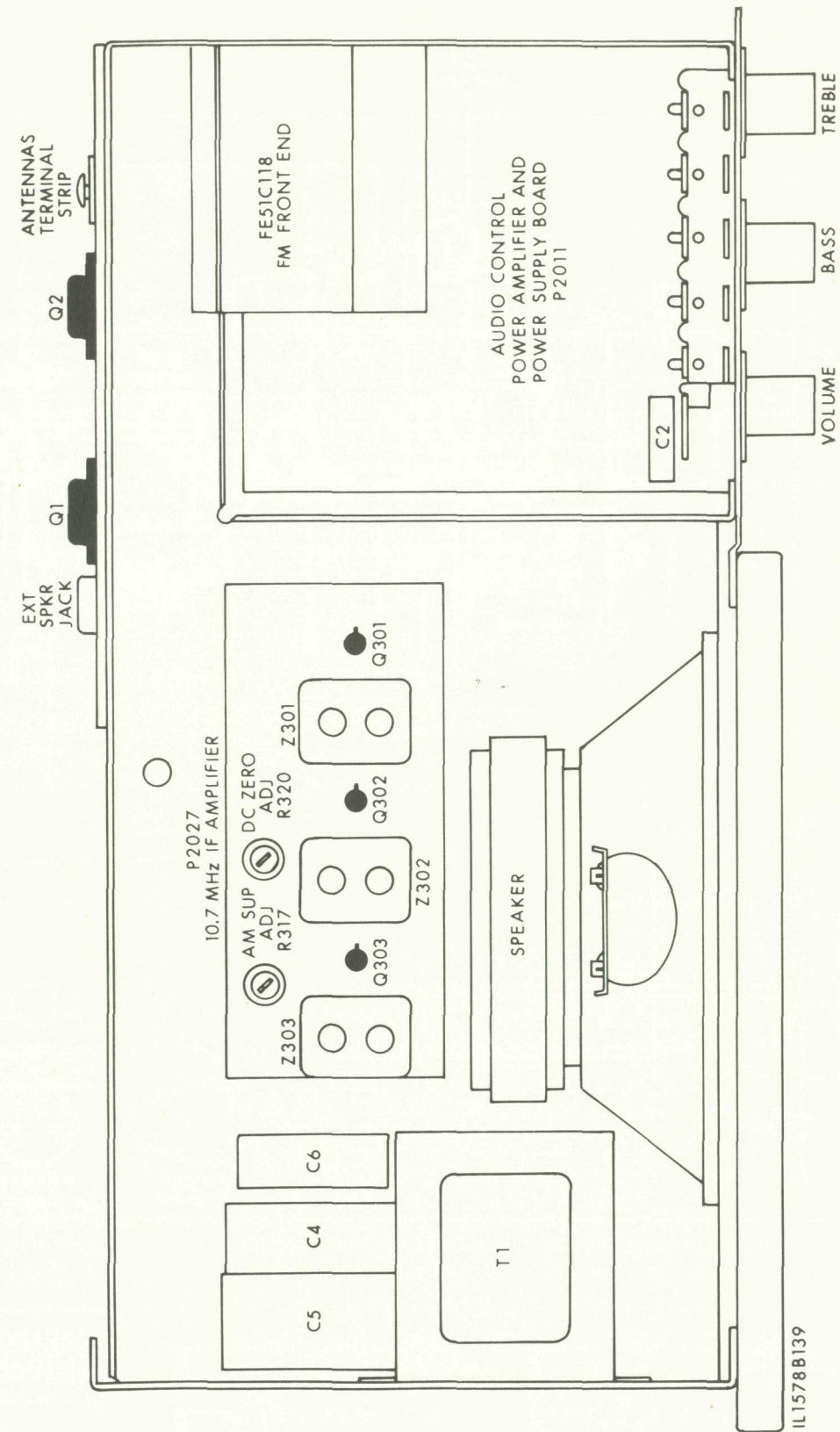

FISHER RADIO CORPORATION · NEW YORK